

NOTES	
1	Modern steps.
2	Pillar and column-headed columns.
3	Undetermined doorway that breaks into side chamber Fa of KV 10.

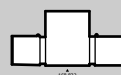
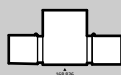
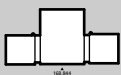
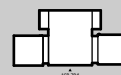
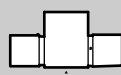
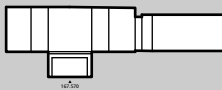
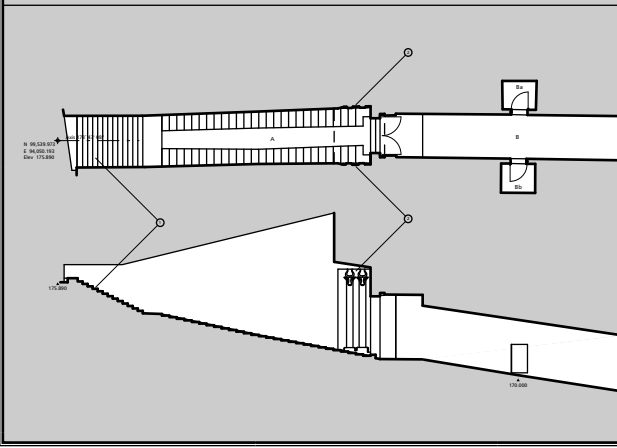
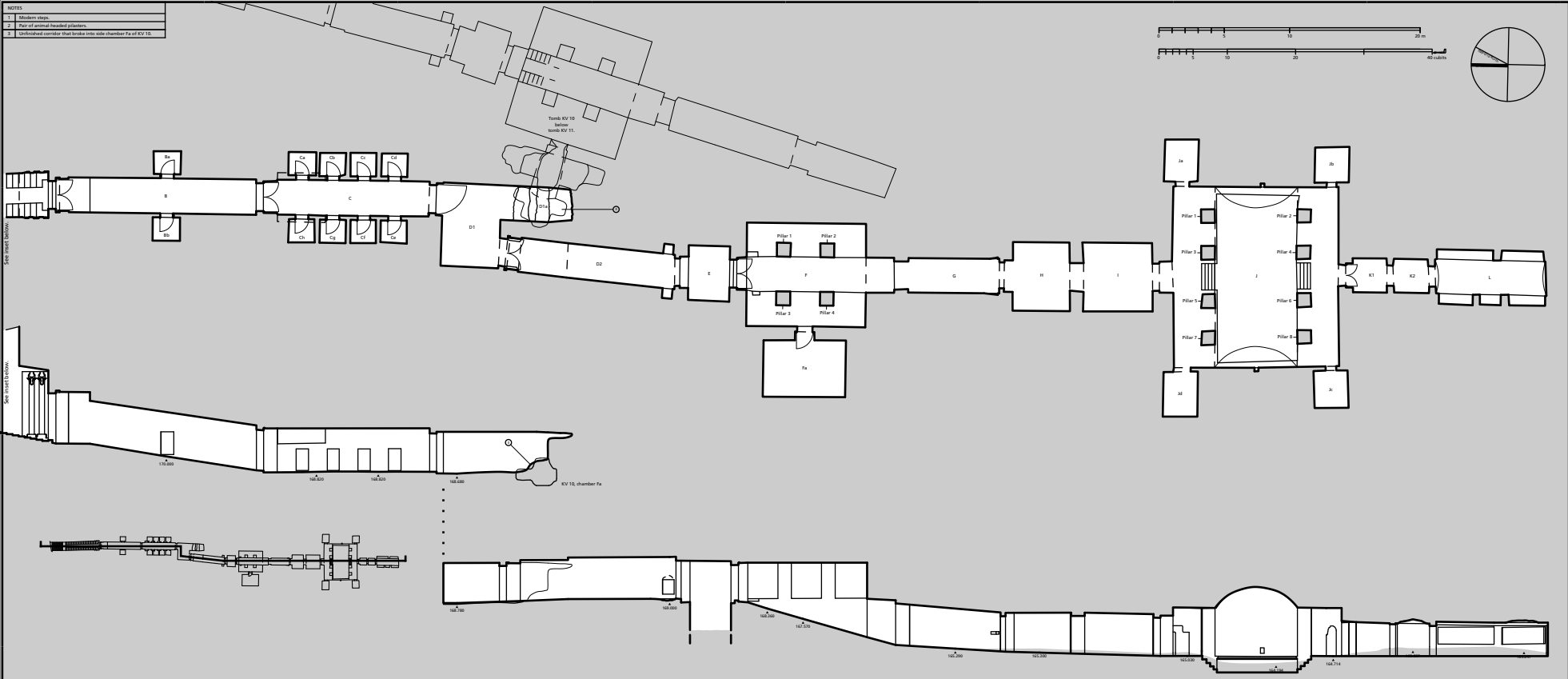
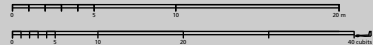

Rooms Ba - B - Bb

Rooms Ca - C - Ca

Rooms Cg - C - Cb

Rooms Cf - C - Cc

Rooms Ce - C - Cd

KV 11 - Ramesses III  
 Plan, sections 1:25  
 Dyn. XX  
 Sheet 56/72 - KV 11 (1/2)

